

Globlazer

Your love, We prove

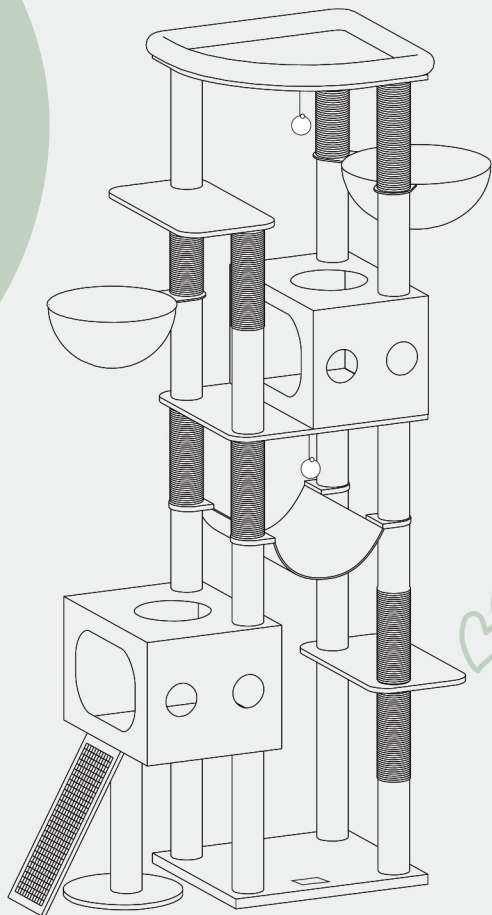

S81G

General Guidelines

- Please read the following instructions carefully and use the product accordingly.
- Please keep this manual and hand it over when you transfer the product.
- This summary may not include every detail of all variations and necessary steps. Please contact us when further information and help are needed.

Notes

- The scratching post is only intended for cats to play, climb, and sharpen their claws. The seller does not assume any responsibility or liability with respect to any damage caused by incorrect assembly or improper use.
- The product is intended for indoor use only, not for commercial use or outdoor use.
- During the installation, please follow the correct steps and take necessary security measures, such as wearing a pair of gloves, to avoid injuring your hands.
- After installation, please check and tighten all screws. Then, 2-3 days later, check again to ensure that the screws are properly tightened.
- Check the firmness of all the screws at least once a month.
- Do not put any other objects on the cat tree.
- After assembly, place the product in a well-ventilated area for 3-5 days to eliminate the smell.
- Make sure the product is placed on an even floor to prevent toppling hazards. It is recommended to place it against a wall corner and use the included anti-toppling fittings to secure it to the wall.
- Use a hair remover for daily care. Do not clean with water or other liquid detergents. Always keep the cat tree dry.
- Keep away from heat sources, humidity, and corrosive chemicals, and avoid direct sunlight. Otherwise, it may cause damage and shorten the lifespan of the product.

Warnings

- This product is not a toy. Do not stand or climb to avoid the risk of injuries. Keep away from children. Be aware of danger!
- If your cat starts to chew or eat the furry balls or elastic band, please remove the toys and keep them out of the reach of your cat.
- Persons with allergies should avoid assembling the product.
- Keep children away during assembly as small parts may be fatal if swallowed or inhaled. Keep all packaging materials (film, plastic bag, foam, etc.) out of the reach of children and babies to avoid choking, suffocation, and other potential risks.

Safety Advisory: If your cat is still young or particularly intrigued by the plush ball (featuring a toy bell) included with this product, please take the following precautions promptly to keep your pet safe:

- To minimize the risk of accidental swallowing, kindly remove the bell from the plush ball.
- Always supervise your cat while it plays with this toy, especially if there are no adults around, to prevent any potential mishaps.
- Regularly inspect the toy for wear and tear, ensuring it does not have any loose parts that could pose a risk.

Allgemeine Richtlinien

- Bitte lesen Sie die folgende Anleitung sorgfältig und bedienen Sie das Produkt entsprechend.
- Halten Sie bitte diese Handbuch und übergeben Sie es, wenn Sie das Produkt weitergeben.
- Diese Zusammenfassung möglicherweise nicht alle Details zu allen Variationen und erforderlichen Schritten enthält. Bitte kontaktieren Sie uns, wenn Sie weitere Informationen und Hilfe benötigen.

Hinweise

- Die Kratzpost ist nur für Katzen gedacht, um zu spielen, zu klettern und ihre Klauen zu schärfen. Der Verkäufer übernimmt keine Verantwortung für Schäden, die durch falsche Montage oder unsachgemäße Verwendung verursacht werden.
- Das Produkt ist nur für den Innengebrauch bestimmt, nicht für kommerziellen Zwecke oder für den Außengebrauch.
- Beim Einbau folgen Sie bitte die korrekte Anleitung und ergreifen Sie die notwendige Sicherungsmaßnahmen, wie zum Beispiel Handschuhe zu tragen, um Verletzungen zu vermeiden.
- Nach dem Einbau, bitte alle Schrauben überprüfen und festziehen. Dann 2-3 Tage später erneut überprüfen, um sicherzustellen, dass die Schrauben richtig fest sind.
- Überprüfen Sie die Festigkeit aller Schrauben mindestens einmal im Monat.
- Bitte keine andere Gegenstände auf den Katzenbaum legen.
- Nach der Montage, bitte das Produkt in einem gut belüfteten Raum für 3-5 Tage stellen, um den Geruch zu beseitigen.
- Sicherstellen Sie, dass das Produkt auf einem ebenen Boden steht, um Sturzgefahren zu verhindern. Es ist empfohlen, es an eine Wandecke zu stellen und die mitgelieferten Anti-Sturz-Fittings zu verwenden, um es an die Wand zu sichern.
- Verwenden Sie einen Haarabstreifer für die tägliche Pflege. Nicht mit Wasser oder anderen flüssigen Reinigungsmitteln reinigen. Halten Sie den Katzenbaum immer trocken.
- Halten Sie es von Wärmequellen, Feuchtigkeit und korrosive Chemikalien fern und vermeiden Sie direkte Sonneneinstrahlung. Andernfalls kann es zu Beschädigungen kommen und die Lebensdauer des Produkts verkürzen.

Warnhinweise

- Dieses Produkt ist kein Spielzeug. Nicht stehen oder klettern, um Verletzungsrisiken zu vermeiden. Von Kinder fernhalten. Achtung vor Gefahr!
- Wenn Ihre Katze beginnt, die Fellbälle oder den Gummiband zu kauen oder zu essen, bitte die Spielzeuge entfernen und sie außerhalb der Reichweite Ihrer Katze halten.
- Personen mit Allergien sollten die Montage vermeiden.
- Halten Sie Kinder während der Montage fern, weil kleine Teile tödlich sein können, wenn sie verschluckt oder einatmet werden. Halten Sie alle Verpackungsmaterialien (Film, Plastiktasche, Schaumstoff, etc.) außerhalb der Reichweite von Kindern und Babys, um Erstickengefahren und andere potenzielle Risiken zu vermeiden.

Sicherheitshinweis: Wenn Ihre Katze noch jung ist oder besonders von dem mitgelieferten Plüschball (mit einer Spielzeugglocke) fasziniert ist, bitte die folgende Vorsichtsmaßnahmen prompt ergreifen, um Ihr Tier zu schützen:

- Um das Risiko von versehentlichem Verschlucken zu minimieren, bitte die Glocke von dem Plüschball entfernen.
- Immer Ihre Katze beaufsichtigen, während sie mit diesem Spielzeug spielt, besonders wenn keine Erwachsene in der Nähe ist, um potenzielle Unfälle zu verhindern.
- Regelmäßig das Spielzeug auf Verschleiß und Abnutzung überprüfen, um sicherzustellen, dass es keine lose Teile hat, die eine Gefahr darstellen könnten.

一般的なガイドライン

- ・以下の説明書をよくお読みになり、それに従って製品をご使用ください。
- ・この説明書は大切に保管し、製品を譲渡する際には一緒に渡してください。
- ・この要約には、すべてのバリエーションや必要な手順の詳細が含まれていない場合があります。さらなる情報やサポートが必要な場合は、当社までお問い合わせください。

注意事項

- ・このキャットタワーは、猫が遊び、登り、爪を研ぐためにのみ使用してください。販売者は、不適切な組み立てや不適切な使用によって生じた損害について、一切の責任を負いません。
- ・この製品は室内専用です。商業用や屋外での使用はできません。
- ・組み立ての際は、正しい手順に従い、手を傷つけないように手袋などの安全対策を講じてください。
- ・組み立て後は、すべてのネジがしっかりと締まっていることを確認してください。その後、2〜3日後に再度確認し、ネジが適切に締まっていることを確認してください。少なくとも月に1回はすべてのネジの締め具合を点検してください。
- ・キャットタワーの上には、他の物を置かないでください。
- ・組み立て後は、製品を風通しの良い場所に3〜5日間置いて、臭いを消してください。
- ・製品は平らな床に置いてください。転倒の危険を防ぐため、壁の角に置き、付属の転倒防止金具を使用して壁に固定することをお勧めします。
- ・日常のお手入れには、毛取り器を使用してください。水やその他の液体洗剤で洗浄しないでください。キャットタワーは常に乾燥した状態に保ってください。
- ・熱源、湿気、腐食性のある化学物質から遠ざけ、直射日光を避けてください。さもないと、製品が損傷し、寿命が短くなる可能性があります。









警告

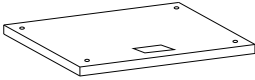

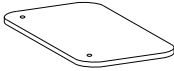
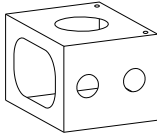
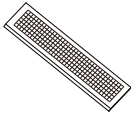
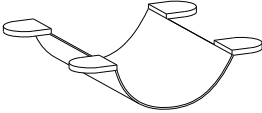
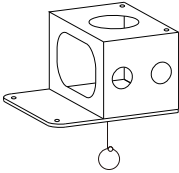

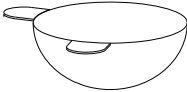
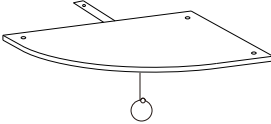

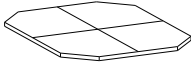
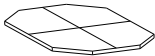

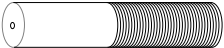
- ・この製品は玩具ではありません。怪我の危険を避けるため、製品の上に立ったり登ったりしないでください。子供の手の届かない場所に保管してください。危険に注意してください！
- ・猫が毛玉やゴムバンドを嘔んだり食べたりし始めた場合は、おもちゃを取り外し、猫の手の届かない場所に保管してください。
- ・アレルギー体質の方は、組み立てを避けてください。
- ・組み立ての際は、小さな部品が飲み込まれたり吸い込まれたりすると致命的な事故につながる可能性があるため、子供を近づけないでください。また、窒息やその他の危険を避けるため、すべての包装材料（フィルム、ビニール袋、発泡スチロールなど）を子供や赤ちゃんの手の届かない場所に保管してください。

安全上の注意

猫がまだ幼い場合や、この製品に付属しているおもちゃの鈴付きぬいぐるみボールに特に興味を示す場合は、以下の注意事項をすみやかに講じてペットの安全を確保してください：

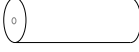
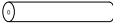
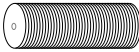
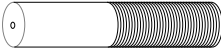
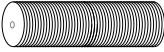
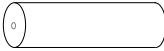
- ・誤飲のリスクを減らすため、ぬいぐるみボールから鈴を取り外してください。
- ・猫がこのおもちゃで遊ぶ際は、特に大人がいない場合は常に監視し、事故を防いでください。
- ・おもちゃの摩耗や破損を定期的に点検し、危険な緩んだ部品がないことを確認してください。

<p>A X1</p> 	<p>B X1</p> 	<p>C X2</p> 
<p>D X1</p> 	<p>E X1</p> 	<p>F X1</p> 
<p>G X1</p> 	<p>H X1</p> 	<p>J X1</p> 
<p>K X1</p> 	<p>L X1</p> 	<p>M X1</p> 
<p>N X1</p> 	<p>P1 X2</p>  <p>350mm</p>	<p>P2 X1</p>  <p>450mm</p>

<p>P3 X1</p>  <p>450mm</p>	<p>P4 X1</p>  <p>362mm</p>	<p>P5 X1</p>  <p>388mm</p>
<p>P6 X1</p>  <p>388mm</p>	<p>P7 X2</p>  <p>200mm</p>	<p>P8 X5</p>  <p>248mm</p>
<p>P9 X8</p>  <p>275mm</p>	<p>P10 X3</p>  <p>248mm</p>	<p>P11 X1</p>  <p>500mm</p>
<p>P12 X2</p>  <p>298mm</p>	<p>P13 X1</p>  <p>326mm</p>	
<p>W1 X34+1</p>  <p>M8x35mm</p>	<p>W2 X12+1</p>  <p>M8x65mm</p>	<p>W3 X4+1</p>  <p>M8x15mm</p>

W4

X2



W5

X1



W6

X1



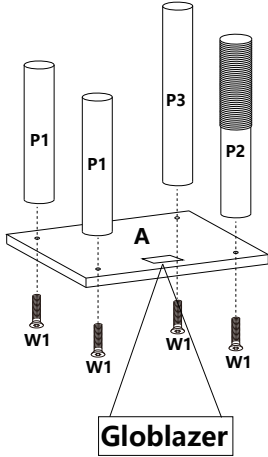

1

W1: 8x35mm
 (4pcs)

**2**

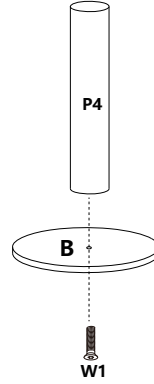
W1: 8x35mm
 (1pc)

**3**

W1: 8x35mm
 (8pcs)

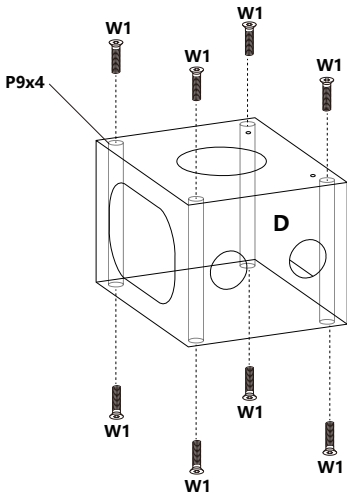
**4**

W3: 8x15mm
 (2pcs)

W4 (2pcs)

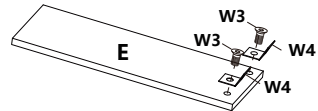

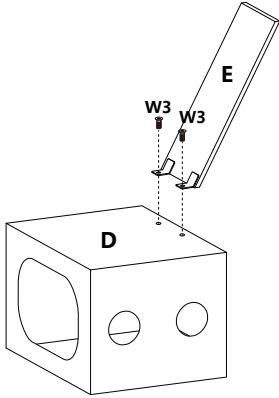

5

W3: 8x15mm
 (2pcs)

**7**

W1: 8x35mm
 (2pcs)

W2: 8x65mm
 (2pcs)

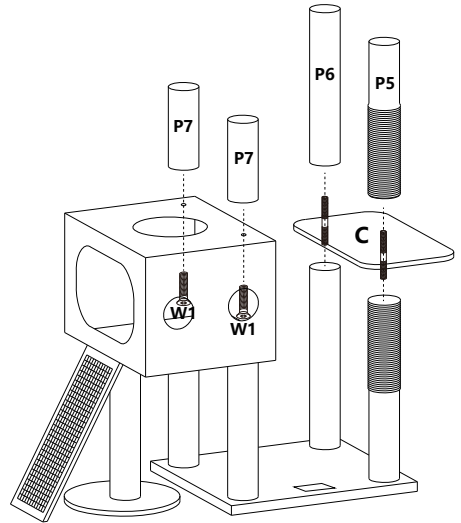
**6**

W1: 8x35mm
 (3pcs)

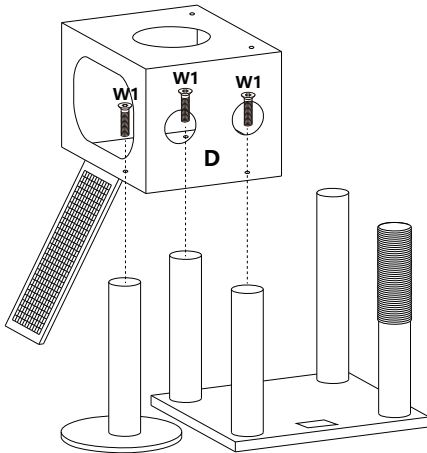

8

W2: 8x65mm
(4pcs)

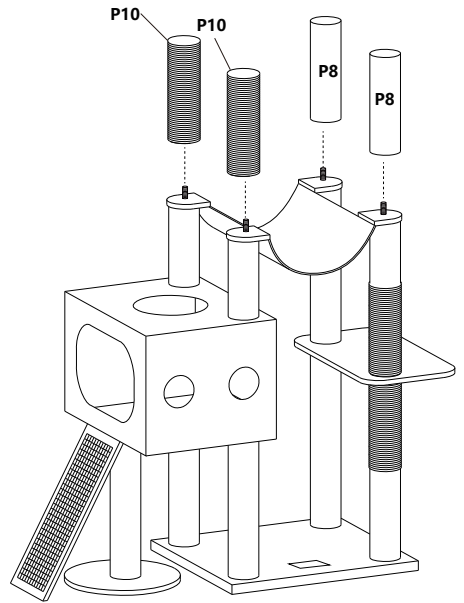
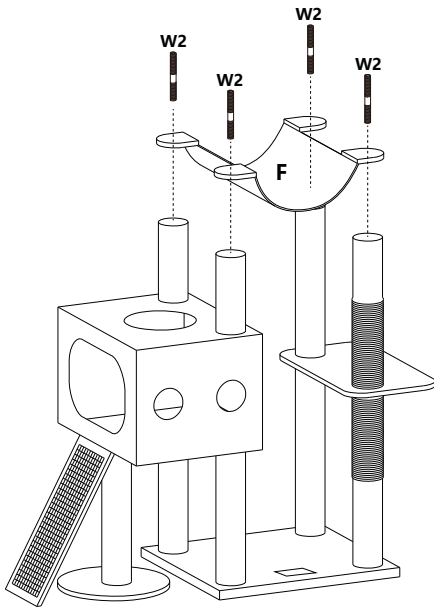
**9**

10

W1: 8x35mm
 (8pcs)

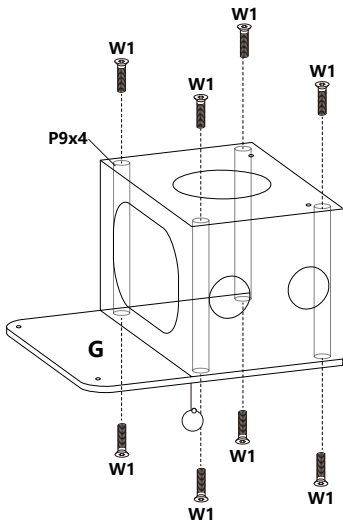

11

W1: 8x35mm
 (2pcs)

W2: 8x65mm
 (2pc)

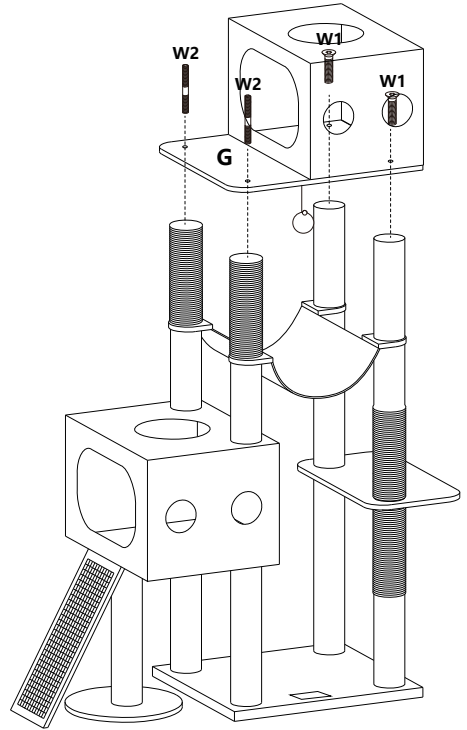

12

W1: 8x35mm
(2pcs)

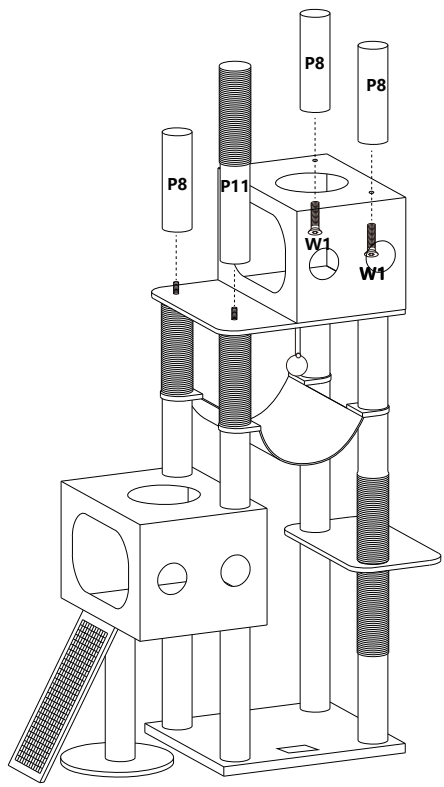

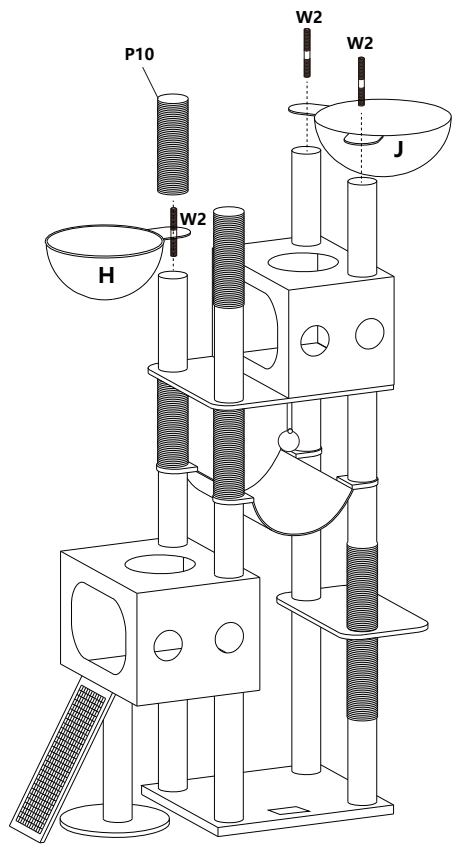

13

W2: 8x65mm
(3pcs)



14

W1:	8x35mm
	(1pc)
W2:	8x65mm
	(1pc)

15

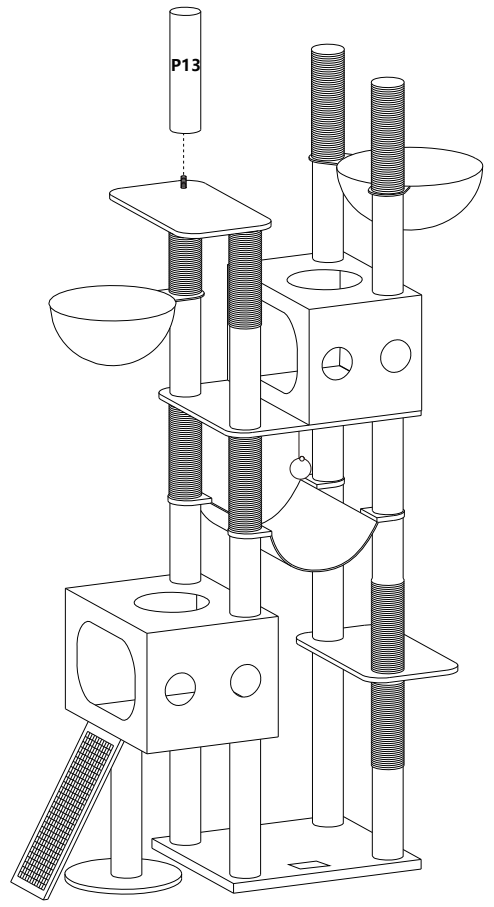
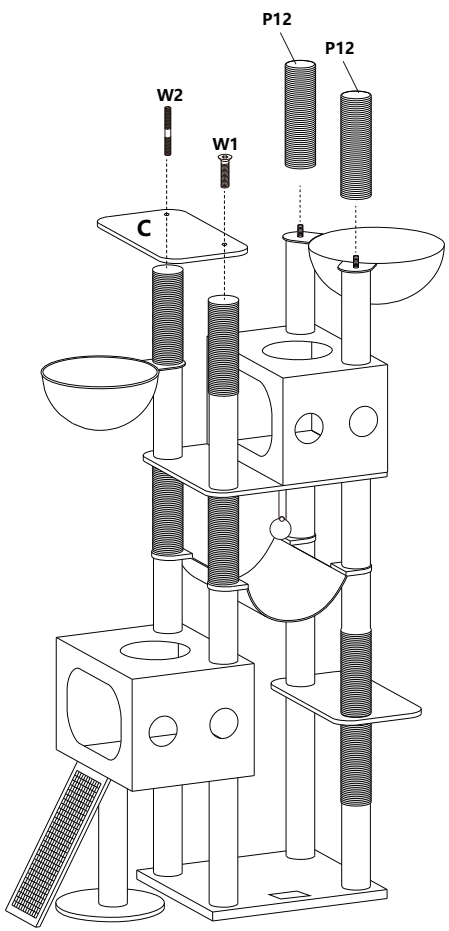

16

W1: 8x35mm
(3pcs)

17

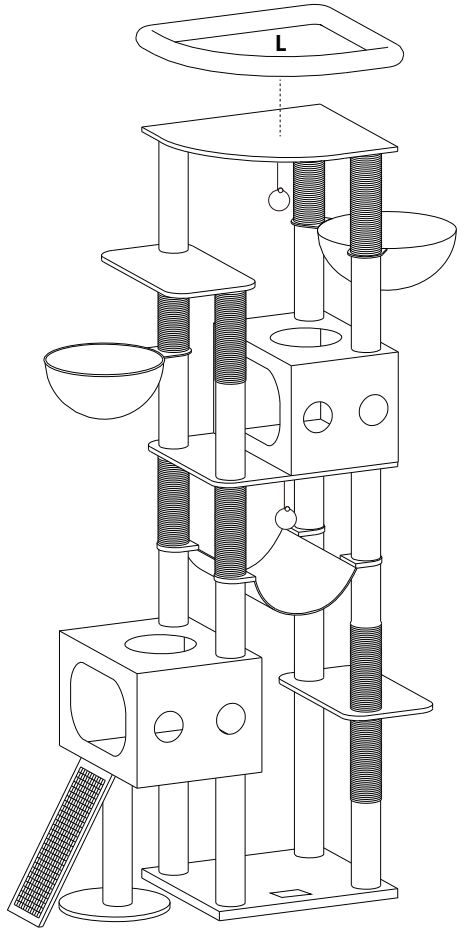
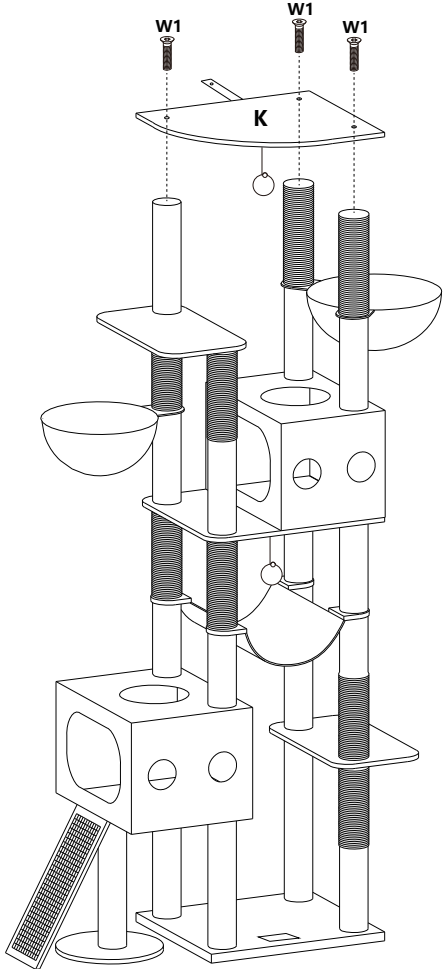

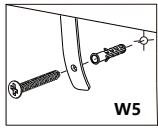

Please use the anti-toppling strap to secure the cat tree to the wall to ensure its stability and safety!

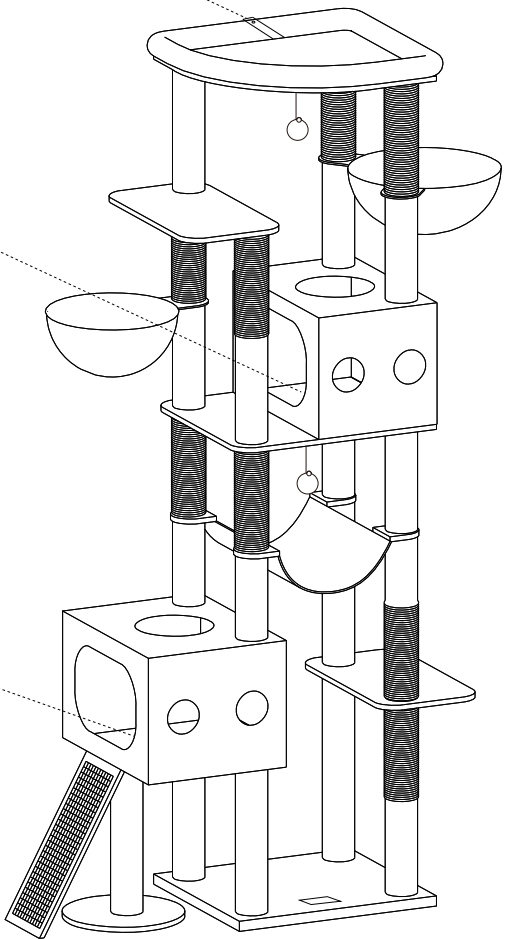
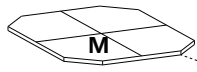
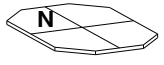

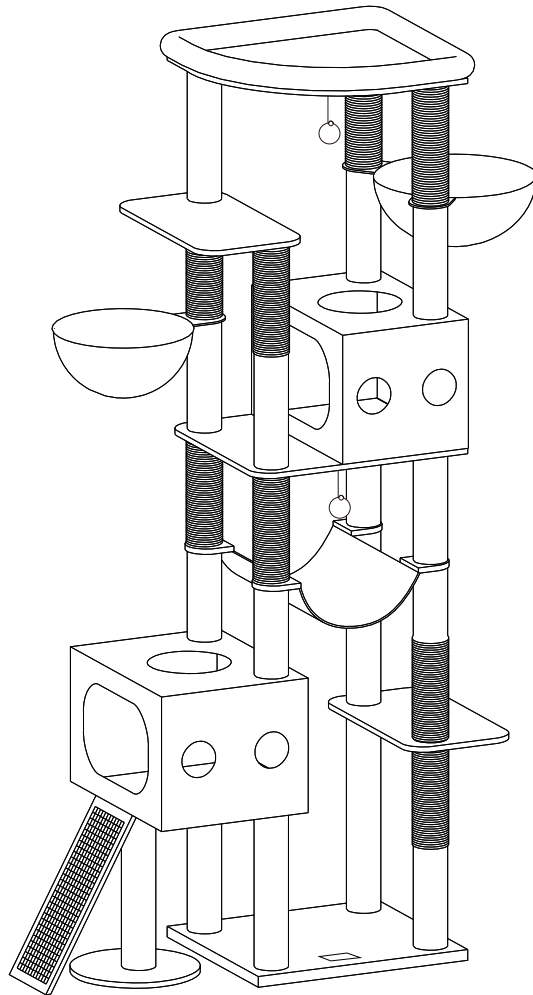

If you have any installation issues, please watch the installation video on the product's listing page, or contact us for technical support.

Even the box it comes in can be made to a cat box with a pair of scissors and some tape in just a few simple steps (scissors and tape are not included).

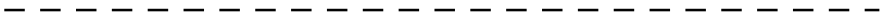
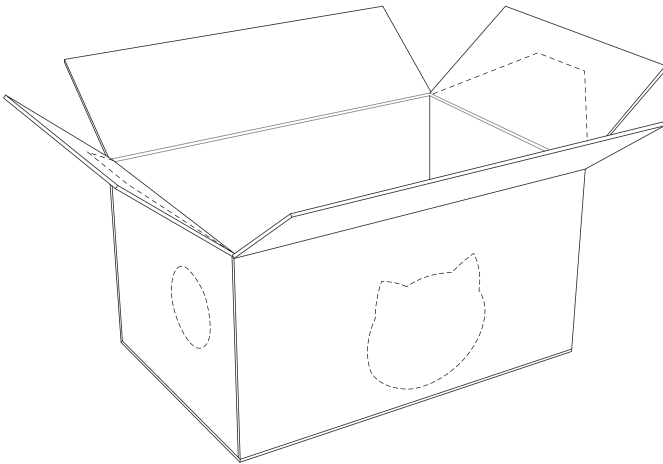
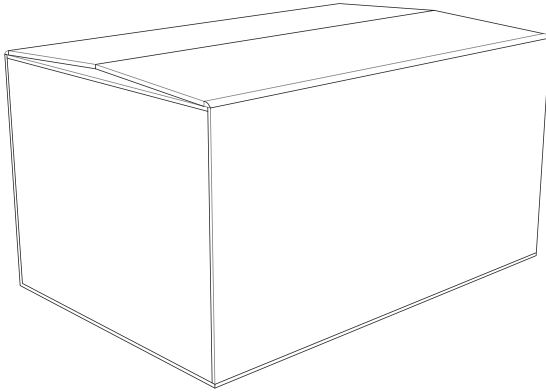

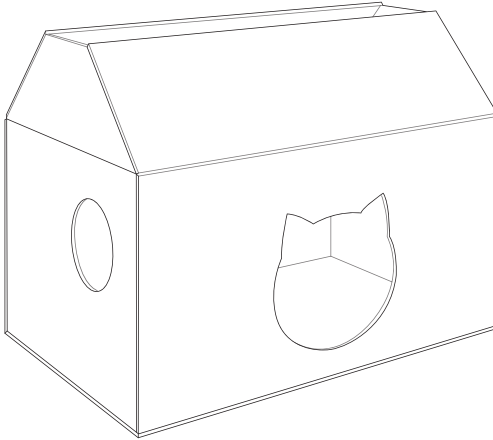
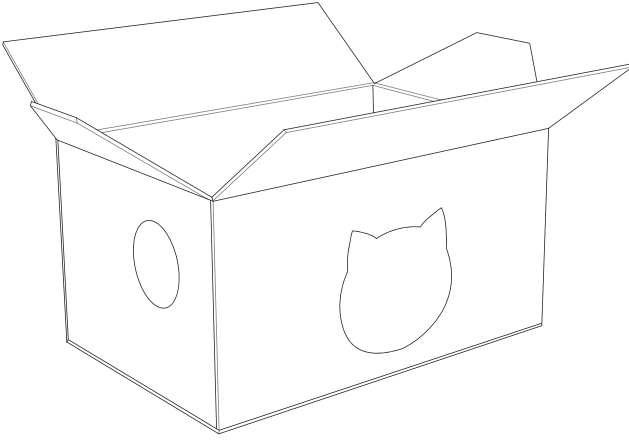



Globlazer

Your love, We prove